

*Discrete lasers from 405 to 980 nm*  
*Single mode, multimode, & PM fiber outputs*  
*Collimation/relay optics*  
*Integrated drive and control electronics*



## Single Wavelength Fiber Coupled Laser

Blue Sky Research is a world leading expert in precision fiber-coupling of laser diodes including; red, green, blue, violet, and IR laser diodes (405nm to 980nm). The FiberTec laser modules feature one fiber-coupled, high performance laser diode with integrated electronics that provide LD drive, temperature stability, protection and other functions. For example, RoHS compliant electronics provides ESD protection, laser driving current monitor, shutdown function, laser modulation and overdrive protection.

## Advantages of Using Fiber

The unique properties of optical fibers allow a reduction in optical systems complexity and enable lower system cost. System performance can be optimized while using cost effective fiber for light relay and beam shaping. A single mode fiber maintains near perfect Gaussian beams without introducing aberrations. In addition, optical fibers maintain beam pointing and steering tolerances throughout temperature variations better than all traditional optics, enabling a robust and stable system performance over wide operation conditions.

## Module Features

- Excellent Beam Quality
- Individually controllable laser
- Integrated drive, power, control circuits
- Very Stable laser power w/low noise
- Custom wavelength and power options
- Single mode, multimode, and PM fiber options
- Rugged OEM grade package

# Fiber-Coupled Laser Modules and Wavelengths

Blue Sky Research offers three different tiers of Fiber-Coupled laser modules to provide customers a variety of options for specific applications. They include;

- FiberTec, a complete laser system with control, stability and monitoring circuits
- FiberDrive, a module without the thermal stability electronics & the TEC
- FiberMax, an OEM component allowing direct access to LD pinouts & a fiber optic pigtail assembly.

Standard wavelengths for all fiber-coupled laser products (FiberTec, FiberDrive and FiberMax) include: 405, 450, 473, 488, 520, 532, 638, 658, 705, 740, 785, 808, 830, 850, 905, and 980nm. Single mode fiber (SMF), polarization maintaining fiber (PM SMF), and multimode (MM) fiber outputs are available as standard options.

Specifications		Popular Wavelengths								
Wavelengths*	nm	405	450	473	488	520	638	658	785	830
Optical Output Power (Max)*	mW	50	40	40	50	50	100	120	50	100
Fiber Mode Field Diameter	μm	3.0	3.5	3.5	3.5	4.0	4.5	4.5	4.5	4.5
SMF Numerical Aperture	NA	0.11	0.11	0.11	0.11	0.11	0.11	0.11	0.11	0.11

\* Contact [Sales@Blueskyresearch.com](mailto:Sales@Blueskyresearch.com) for latest information on Laser Diode wavelength/Power offerings and custom configurations

## General Product Specifications

Optical Parameter	Unit	Min	Typ	Max	Conditions
FiberTec Power Stability (1hr) ( + C* or FFC**)	%			0.5	$\Delta T$ +/- 3 °C, all laser wavelengths
FiberTec Power Stability (24hr) ( + C* or FFC**)	%		1.2	2.0	$\Delta T$ +/- 3 °C, all laser wavelengths
FiberTec Power Stability over Temperature ( + C* )	%		2.5	3.5	$\Delta T = 10^{\circ} - 40^{\circ} 1^{\circ}C/min$
FiberTec Power Stability over Temperature ( + FFC** )	%			1.5	$\Delta T = 10^{\circ} - 40^{\circ} 1^{\circ}C/min$
FiberDrive power Stability (1hr)	%			1.0	$\Delta T$ +/- 3 °C, all laser wavelengths
FiberDrive Power Stability (24hr)	%			3	$\Delta T$ +/- 3 °C, All wavelengths, 24 hrs
Laser Noise, RMS	%			0.5	10Hz – 2MHz, 50-100% Pout, ACC
Laser Noise, Pk-Pk	%			1.2	10Hz – 2MHz, 50-100% Pout, ACC
Polarization w/PM fiber + C*	dB	17	20		Constant Pout
Polarization w/PM fiber + FFC **	dB	23	25		Constant Pout
Laser Warmup Time	min			10	
Laser Shutdown Time	μs			1	

\* Collimator , \*\* Fiber Feedback Collimator

FiberTec and FiberDrive Modules come standard with 1-meter fiber pigtail.

# Fiber-Coupled Laser Modules

Blue Sky Research offer four different tiers of Fiber-Coupled laser modules that provide customer variety of options for specific applications. They include: **FiberTec**, a complete laser system with control, stability and monitoring circuits; The **FiberTec + FFC**, the FiberTec and an active feedback and collimation unit to increase power stability and collimate the output laser beam; the **FiberDrive**, a module without the thermal stability electronics & the TEC; and the **FiberMax**, an OEM component allowing direct access to LD pinouts & a fiber optic pigtail assembly.

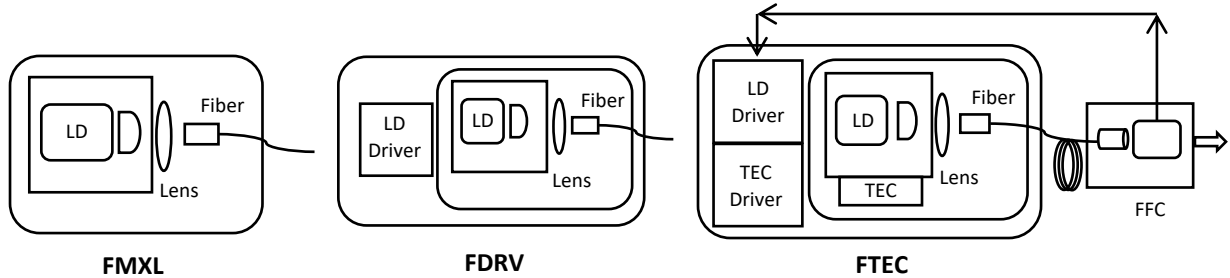

	FMXL	FDRV*	FTEC	FTEC + Collimator	FTEC + FFC
Optical Output	Fiber + Connector	Fiber + Connector	Fiber + Connector	Free Space Collimated beam	Free Space Collimated Beam
Customer Benefits	Low Cost, LD drive electronics not included	Integrated LD Driver Electronics	Laser Power Stability, LD electronics	Laser Power Stability, Beam placement at target	Best optical & laser power stability, high PER

\* FiberDrive can be ordered with collimation or FFC options

## Collimation Optics and Feedback

Blue Sky Research offers two options for collimation; the Fiber Feedback Collimator (FFC), or the miniature cylindrical collimator. The FFC is a combination of an aspheric/doublet lens collimator and an active laser power feedback system. The FiberTec module and FFC combination will provide a stabilized optical output of < 0.5% (after 10 min warm-up) and high polarization extinction ratio > 23dB.

The cylindrical collimator is a miniature lens enclosure secured to the fiber pigtail's connector and houses an aspheric or doublet lens which provides a specific collimated beam diameter and divergence. Both the Fiber Feedback and Cylindrical collimator options have the same beam size and divergence specifications (e.g. M, N, P, Q). Collimated beam specifications must be specified at time of purchase. Please contact Blue Sky Research for exact beam specifications at beam Diameter and divergence are LD (wavelength dependent). Focus optics are available as an option.

Collimator Specifications	M	N	P	Q
Beam Diameter* @ 1/e2 (mm), +/- 25%	0.75	1.25	1.8	4
Beam Divergence (mrad) ** @830nm	1.60	1.00	0.70	0.50
@635nm	1.20	0.80	0.50	0.40
@405nm	0.80	0.55	0.40	0.30

\* Typical data at 635nm, +/- 25% covers all wavelengths, constant temp of 25°C, constant Pout.

\*\* Beam Diameter and Divergence will change with LD wavelength, contact Blue Sky Sales for exact specifications relative to your specific wavelength of interest

# Environmental Specifications

Parameter	Units	Specification		Conditions
		Min	Max	
Operating Temperature	°C	10	40	Non-Condensing
Storage Temperature	°C	-10	85	Non-Condensing
Storage Humidity	%	10	90	Non-Condensing

# Electrical Specifications

Electrical Specification	Units	Specifications	
FiberTec Operating Voltage	V	3.3V $\pm$ 0.25, 5V $\pm$ 0.25V, 6.5V $\pm$ 0.25, 8V $\pm$ 0.25 (laser specific)	
Operating Current	A	1.5A max for 3.3V (TEC), < 0.5A for 5.0V, 6.5V & 8.0V (LD specific)	
Modulation		High-Speed Modulation ACC mode only	Standard Modulation APC or ACC mode
Analog Modulation Frequency		200kHz	10kHz
Rise Time	ns	700	10,000
Fall Time	ns	100	5,000
Dynamic Extinction Ratio	dB	>23	>23

# Evaluation Board for FiberTec – FiberDrive

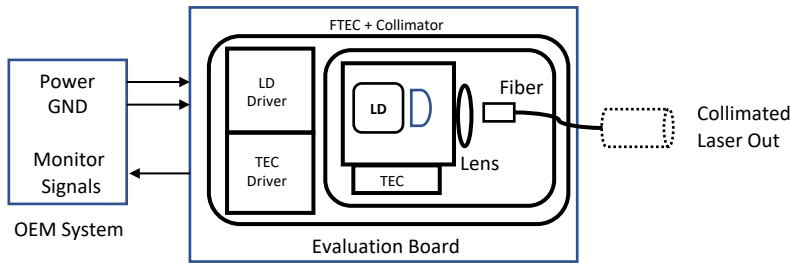

An optional Evaluation Board can quickly get FiberTec or FiberDrive modules (with a 16 Pin interface) running without building a unique PCB. The evaluation board gives users access to the optical output beam and all electrical connections including LD drive, control, monitoring, and protection circuits. The Evaluation Board has a built-in heat sink to help with thermal management, and four corner posts to facilitate system mounting. All details to set up and operate FiberTec and evaluation board are detailed in Application Note: FiberTec/FiberDrive Evaluation Board, Sept. 2019, V 3.0. User must provide power supply for Laser Diodes, and TEC cooler if EB is controlling a FiberTec module.

# ACC and APC Operation

**ACC (automatic current control):** Laser Diode driving current is detected and feedback to control circuit. An error signal is generated to lock the LD current to preset value or user specified setting.

**APC (automatic power control):** Laser power is detected via a back facet monitor inside the laser diode housing (TO can). An error signal is generated to adjust LD current to lock power to preset value or user specified setting.

# Electrical Connection and Operation of FiberTec & FiberDrive

Customer can choose one from two options of electrical connection for FiberTec operation: 16 Pin or 8 wire ribbon. The most advanced interface (16 Pin) uses two rows of 8 pins on the bottom of the unit. You can remotely access all functions available in the FiberTec/FiberDrive.

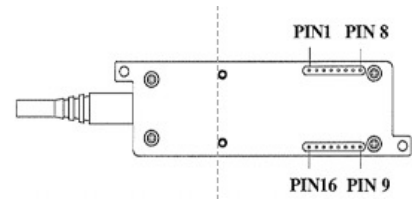

The Pin out locations are shown above. When looking at the bottom of the module and the fiber exiting from the left, Pin #1 is in the upper left-hand corner, and Pin #16 is in the lower left-hand corner.

## Control functions for FiberTec – 16Pin or 8 wire ribbon

Pin No	Wire Ribbon	Name	Type	Description
1	BLUE	DIS	Input	SHUTDOWN, Laser enable/disable, GND active. CMOS HI (>4.2V) to disable, input impedance ~20kΩ
2	GREY	LDV	Output	Laser Diode Monitor, Voltage proportional to drive current on LD (in test report that comes w/FiberTec)
3	YELLOW	GND	Input	Ground
4	GREEN	Vset	Analog Input	Constant Current or Constant Power setting, Variable power input control, 0 ~ 5V
5		Them Mon	Output	Monitor of Thermistor resistance for temperature
6		APC	Input	Connect to Pin 15 to select APC mode operation
7		ACC	Input	Connect to Pin 8 to select ACC Mode operation
8		ACC	Input	Connect to Pin 7 to select ACC mode operation
9	ORANGE	Vcc	Power	LD Driver Circuit Supply Voltage, 5V/6.5V/8V laser specific.
10	YELLOW	GND	Input	Ground
11		Vtemp	Input	Input voltage to change the set temperature of the TEC, typ 1.24V = 25°C
12		TEC OK	Digital Output	Output Hi for TEC within 1 C of set temperature
13	PURPLE	PD Mon	Output	PD Monitor, Voltage is inversely proportional to output power, laser specific, see FiberTec test report
14	BROWN	TEC GND	Input	GND for 3.3V TEC Supply
15		APC	Input	Connect to Pin 6 for APC Mode Operation
16	RED	Vtec	Input	TEC Supply Voltage, 3.3V

If module has an eight-wire ribbon exiting from the rear of the module. the function assignment of each color wire is shown in the table above. If you want to switch between ACC and APC modes of operation manually and you are using the 8 wire configuration, there is a physical jumper located inside the FiberTec box (see right). Moving the jumper from one position to the next changes the mode of operation. All FiberTec and FiberDrive modules without pins use this jumper location for ACC and APC modes.

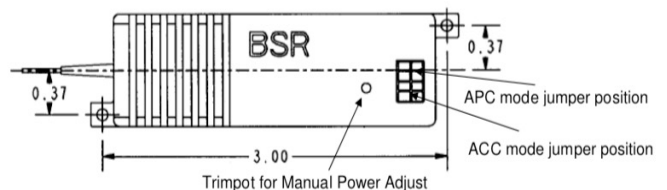

# FiberTec Mechanical Specifications

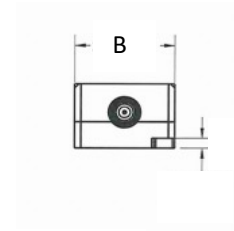
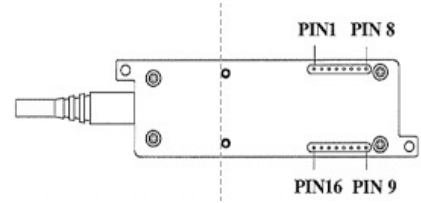
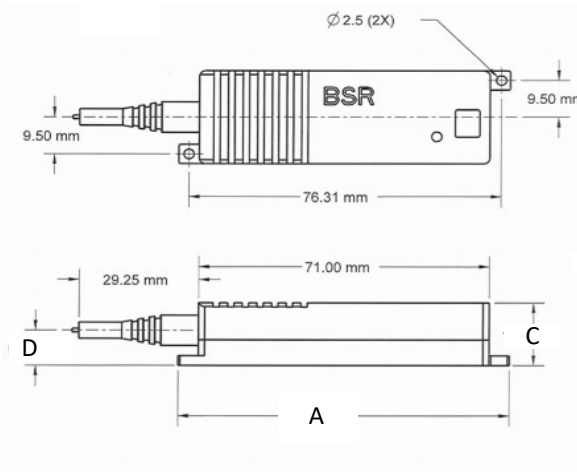

FiberTec Dimension	LD Wavelengths 405nm – 520nm	LD Wavelengths 532nm	LD Wavelengths 635nm - above
<b>A</b> Length	81 mm	81 mm	81 mm
<b>B</b> Width	24 mm	24 mm	24 mm
<b>C</b> Height	16.2 mm	22.6 mm	15 mm
<b>D</b> Fiber Exit Height	9.04 mm	12.5 mm	7.76 mm
<b>E</b> Flange Height	2.5 mm	2.5 mm	4.5 mm

FiberTec and FiberDrive modules come with 1 meter connectorized fiber pigtail output as standard. Fiber Jacketing options include a 900µm PVC jacket with a bend radius of 13mm or an 3mm Armored metal jacket with Bend radius of 30mm.

# FFC: Fiber Feedback Collimator

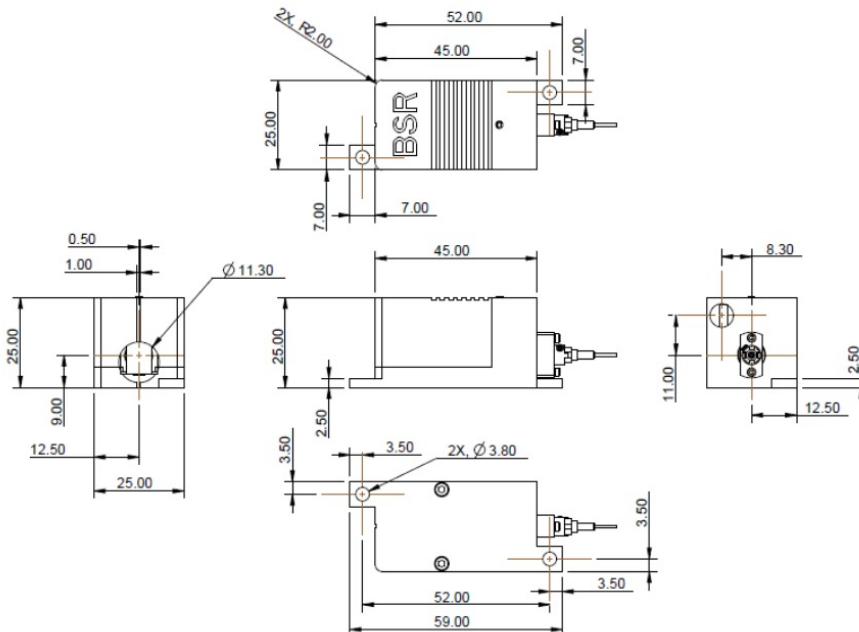

# Cylindrical Collimators

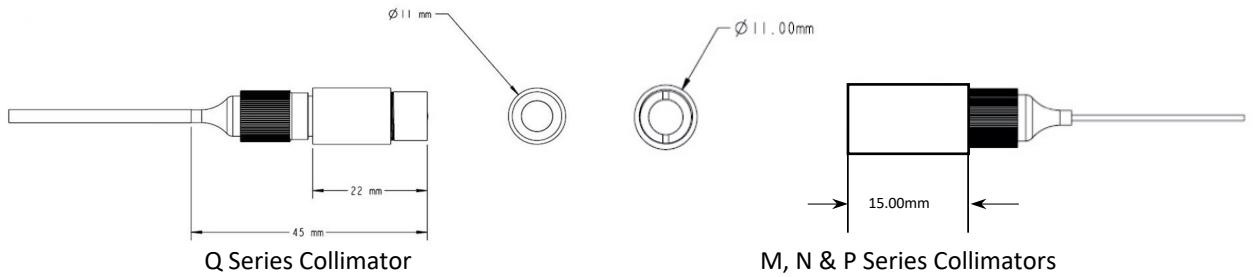

## Ordering Information

FTEC-XXX-YZZZ-A-BCDE

Product Family – FTEC, FDRV or FTEV

FTEC = single wavelength laser system w/TEC, control, drive & stability circuits

FDRV = single wavelength laser w/control, drive circuits, no TEC

FTEV = FTEC + separate evaluation board

XXX - Wavelength in nm – from table 2, e.g. 635 for 635nm LD

Y - O = Wire ribbon interface, with manual trimpot power adjust

- V = Wire ribbon interface, (only option for FTEC2-532)

- P = Pin interface

- M = High Speed Modulation (200kHz), wire ribbon interface

- H = High Speed Modulation (200kHz), pins Interface

ZZZ - Power Output (mW) pick from table 2, e.g. 025 for 25mW, 100 for 100mW

A - Fiber type: S = smf, P = Polarization Maintaining smf (PM), M = Multi Mode

B - Optical Connector: F = FC/PC, A = APC

C - Collimator choice: O = no collimator, F= FFC, G = Cylinder,

D – Collimator lens - M, N, P, Q see table 1 for details, O = no collimator lens

E – H = 3mm buffer, J = 3mm armored metal jacket, K = 900um PVC Jacket

## Ordering Examples

**FTEC- 638- P100-P-FFQJ** = FiberTec, 638nm, 16 pin interface, 100mW output, PM single mode fiber, FC/PC connector, FFC, 3mm collimated beam, and 1-meter armored cabling between FTEC and FFC.

**FTEC- 488- H050-S-AGNK** = FiberTec, 488nm, 16 pin interface with 100kHz high speed modulation, 50mW output, single mode fiber, APC connector, cylinder collimator, 1.25mm collimated beam, and 1-meter 900µm PVC jacket between FTEC and cylindrical collimator.

**FTEC- 532- V025-S-AOOK** = FiberTec, 532nm, 8 wire ribbon cable, 25mW output, single mode fiber, and 1-meter 900µm PVC jacket, APC connector. No collimator housing or lens ordered.

## Blue Sky Research

510 Alder Drive, Milpitas, CA 95035  
P: (408) 941-6068 | F: (408) 941-0406

ISO 9001:2015 Certified

[Sales@blueskyresearch.com](mailto:Sales@blueskyresearch.com) [www.blueskyresearch.com](http://www.blueskyresearch.com)

